

Slant/Fin SC-9 Caravan Modular Boiler Control

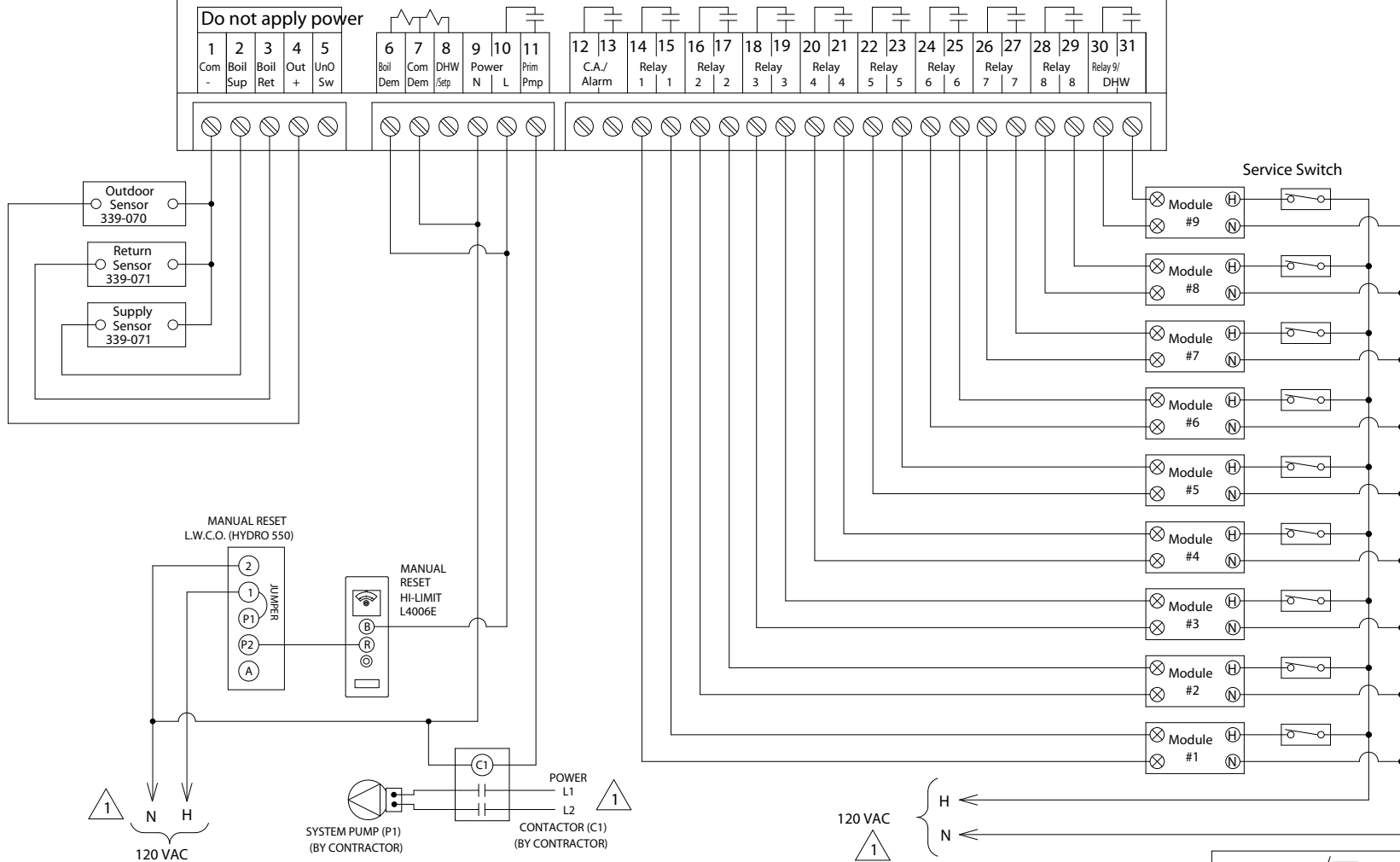

NOTES:

1 - Provide Disconnect Means and Overload Protection as Required by Local Code.

Slant/Fin SLANT/FIN CORPORATION		
100 FOREST DRIVE, GREENVALE, NEW YORK 11548 / 516-484-2600		
TITLE SC-9 CONTROLLER WIRING 9 MODULE, GAS SYSTEM		
DATE 4-20-05	DRAWN BY AC	DRAWING NUMBER
DATE	APPROVED	SC9-9H-1